

# TECHNICAL DATA SHEET

## Technical Parameters

Modello: SLL001-A

- The luminaire is made from non-insulating aluminum.
- It can be modulated in different ways according to requirements.
- Ideal for exhibitions, galleries, bars, cafes, restaurants and other commercial premises.

## Technical Parameters

Model	SLL001-A
Power	7.5W
PF	0.9
CRI	≥80
CCT	4000K
Luminous efficiency	100lm/w
Lumen	750lm
Angle	110°
UGR	<26
Size	L250*W55*H75mm
Color	Black
Input Voltage Input	220V-240V
IP Protection	IP40
Warranty	3 Years
Certification	CE, RoHS

Product image:

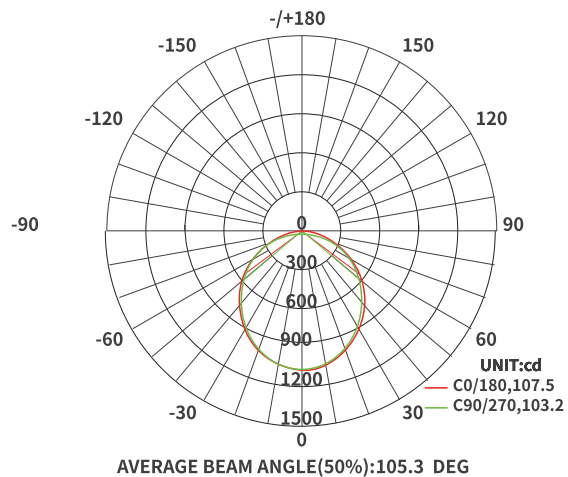
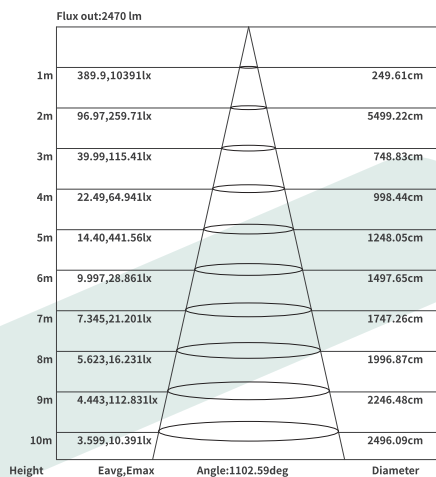
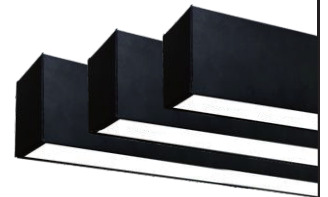

SLL001-A (110°)

## Diagramma delle dimensioni:

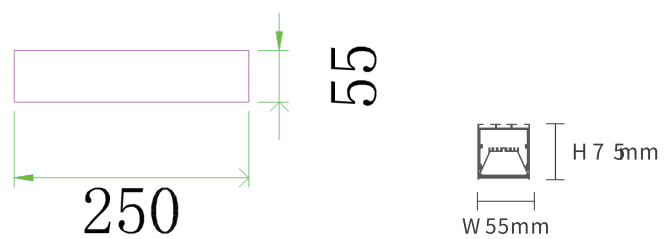

## Installation method:

Installation mode

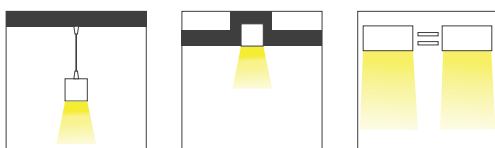

Steel suspension cable



# TECHNICAL DATA SHEET

KOSOON®

## Caratteristiche :

Modello: SLL001-A

- The luminaire is made from non-insulating aluminum.
- It can be modulated in different ways according to requirements.
- Ideal for exhibitions,galleries,bars,cafes,restaurants and other commercial premises.

## Technical Parameters:

Model	SLL001-A
Power	15W
PF	0.9
CRI	≥80
CCT	4000K
CEfficiency Light	88lm/w
Lumen	1320lm
Angle	110°
UGR	<26
Size	L500*W55*H75mm
Color	Black
Input Voltage	220V-240V
IP Protection	IP40
Warranty	3 years
Certification	CE, RoHS

Immagine Prodotto:

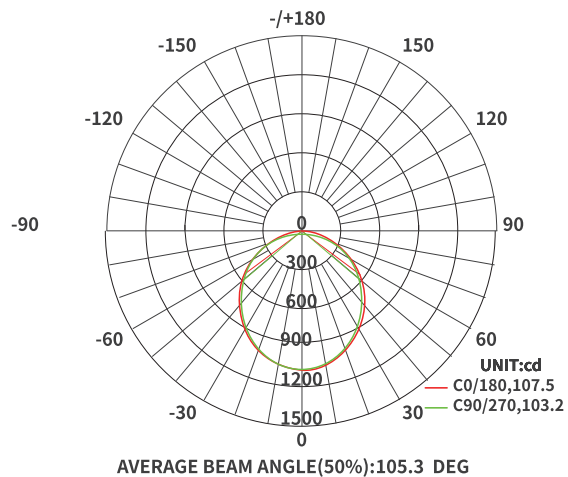
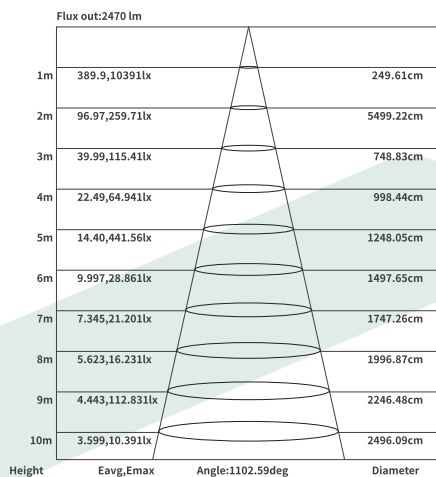
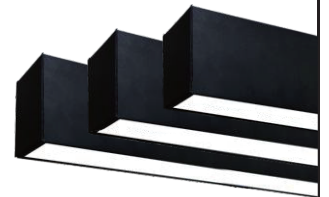

SLL001-A(110°)

Size diagram:

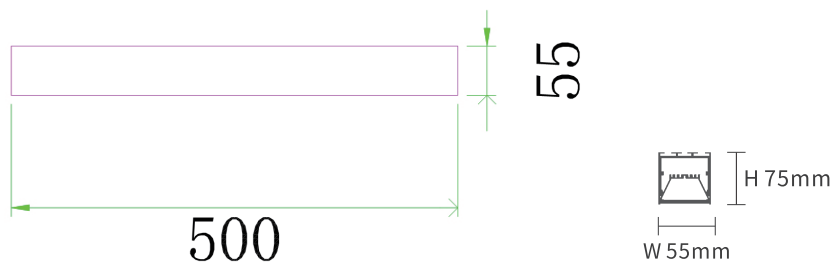

Installation method

Installation mode

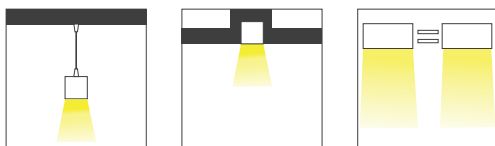

Steel suspension cable



# TECHNICAL DATA SHEET

## Caratteristiche :

Modello: SLL001-A

- The luminaire is made from non-insulating aluminum.
- It can be modulated in different ways according to requirements.
- Ideal for exhibitions, galleries, bars, cafes, restaurants and other commercial premises.

## Technical Parameters:

Model	SLL001-A
Power	24W
PF	0.9
CRI	≥80
CCT	4000K
CEfficiency Light	87lm/w
Lumen	2080lm
Angle	110°
UGR	<26
Size	L500*W55*H75mm
Color	Black
Input Voltage	220V-240V
IP Protection	IP40
Warranty	3 years
Certification	CE, RoHS

Product Image:

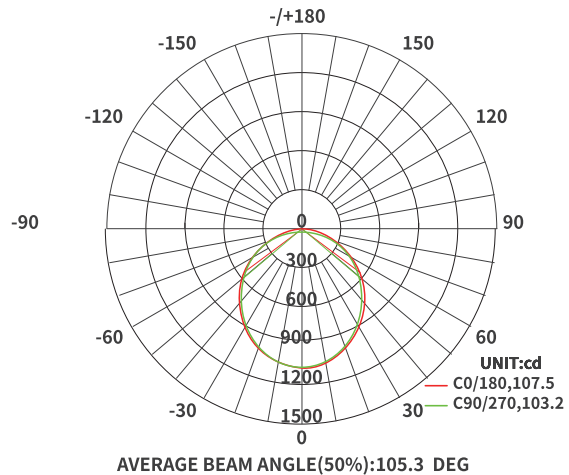
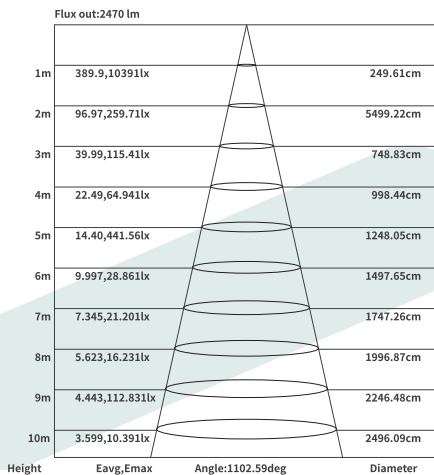
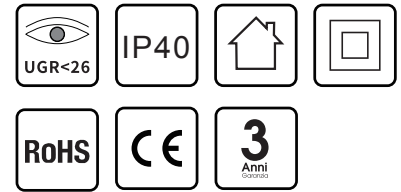
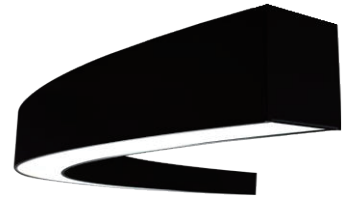

SLL001-A(110°)

Size diagram:

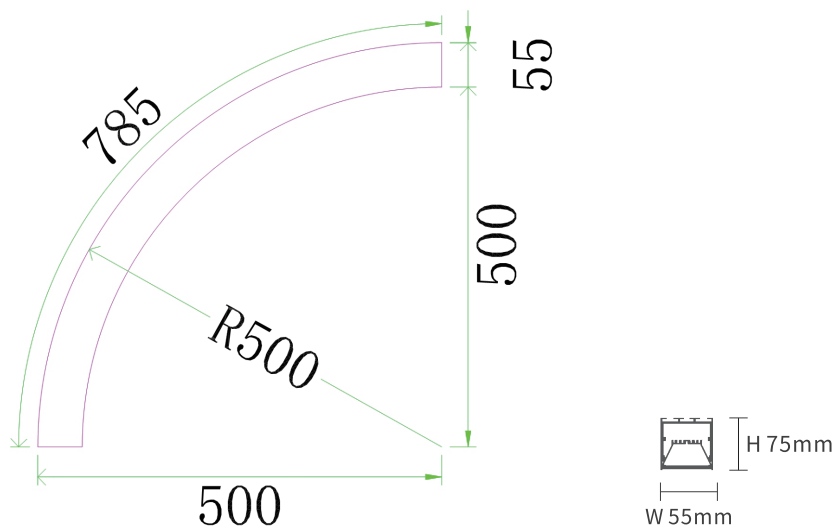

Installation method

Installation mode

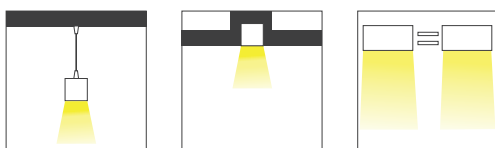

Steel suspension cable



# TECHNICAL DATA SHEET

KOSOON®

## Caratteristiche :

Modello: SLL001-A

- The luminaire is made from non-insulating aluminum.
- It can be modulated in different ways according to requirements.
- Ideal for exhibitions,galleries,bars,cafes,restaurants and other commercial premises.

## Technical Parameters:

Model	SLL001-A
Power	30W
PF	0.9
CRI	≥80
CCT	4000K
CEfficiency Light	92lm/w
Lumen	2760lm
Angle	110°
UGR	<26
Size	L1000*W55*H75mm
Color	Black
Input Voltage	220V-240V
IP Protection	IP40
Warranty	3 years
Certification	CE, RoHS

Immagine Prodotto:

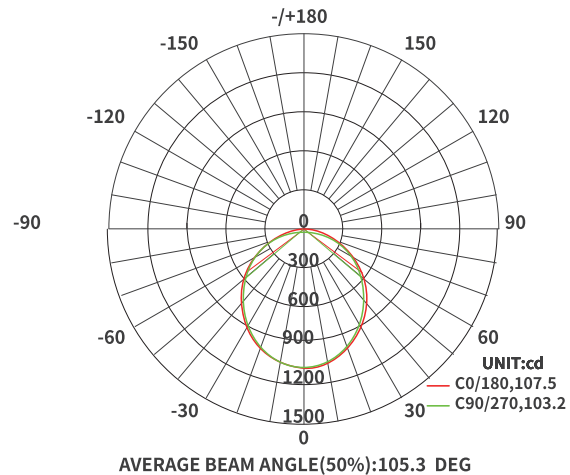
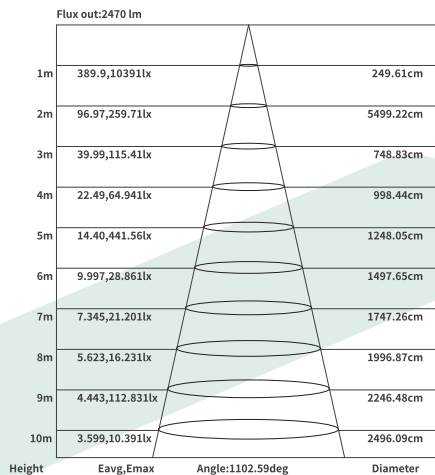
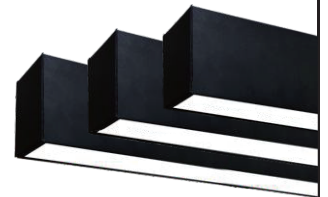

SLL001-A(110°)

Size diagram:



Installation method

Installation mode

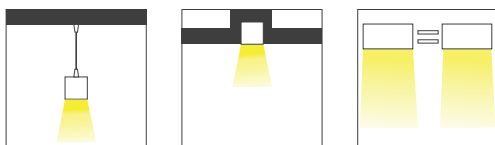

Steel suspension cable





# TECHNICAL DATA SHEET

## Caratteristiche :

Modello: SLL001-A

- The luminaire is made from non-insulating aluminum.
- It can be modulated in different ways according to requirements.
- Ideal for exhibitions,galleries,bars,cafes,restaurants and other commercial premises.

## Technical Parameters:

Model	SLL001-A
Power	48W
PF	0.9
CRI	≥80
CCT	4000K
CEfficiency Light	102lm/w
Lumen	4890lm
Angle	110°
UGR	<26
Size	L1000*W55*H75mm
Color	Black
Input Voltage	220V-240V
IP Protection	IP40
Warranty	3 years
Certification	CE, RoHS

## Immagine Prodotto:

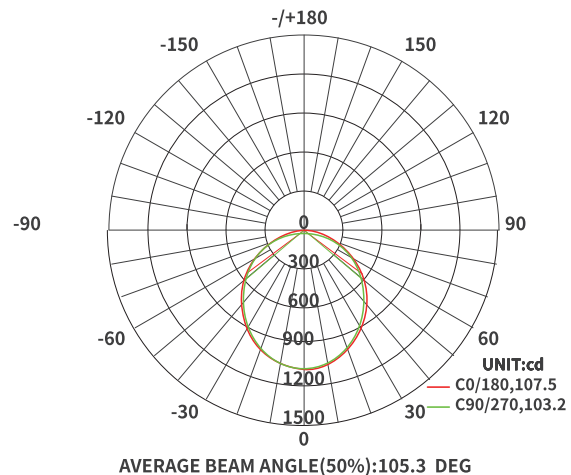
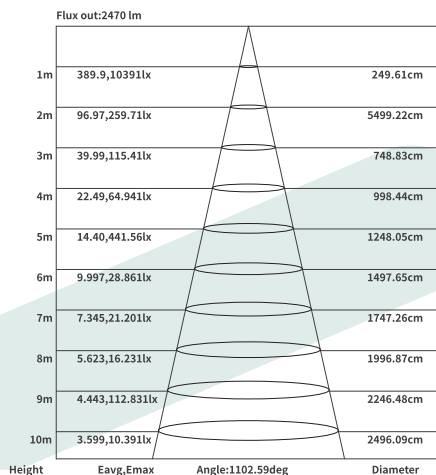
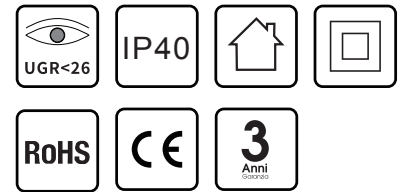

SLL001-A(110°)

Size diagram:

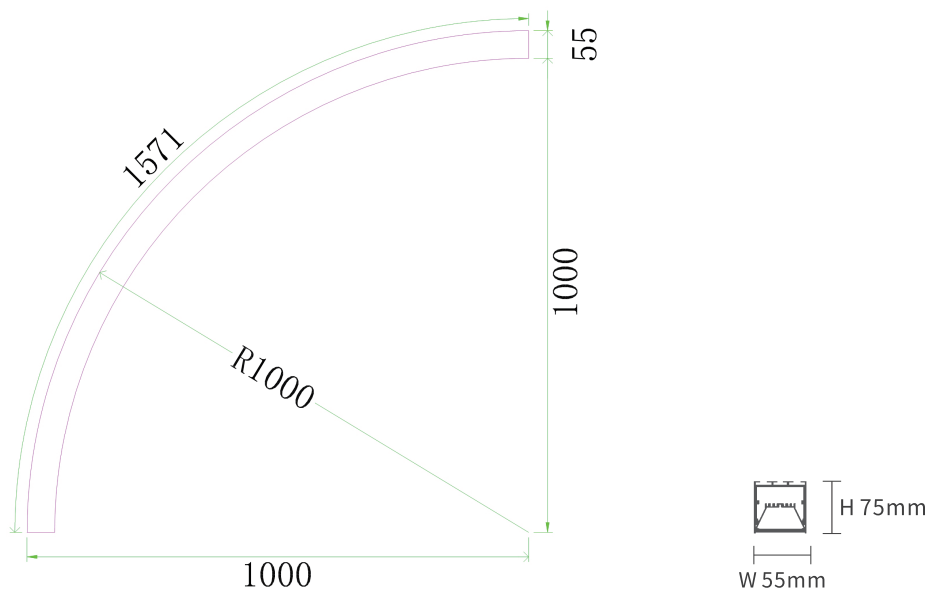

Installation method

Installation mode

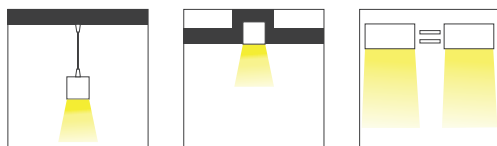

Steel suspension cable

